

Le valvole ISO 1, ISO 2 e ISO 3 hanno dimensioni delle superfici di montaggio conformi alla ISO5599/1. Disponibili nelle versioni 5 vie a 2 e 3 posizioni e con azionamenti di tipo pneumatico od elettrico.

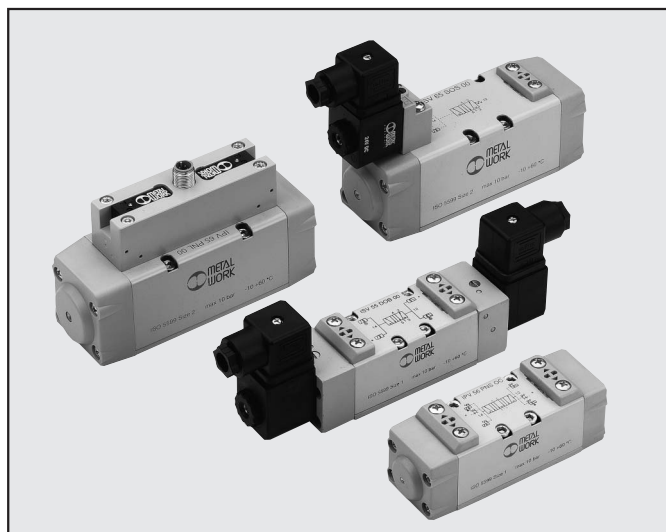

DATI TECNICI	ISO 1	ISO 2	ISO 3
Fluido	Aria compressa filtrata senza lubrificazione; la lubrificazione, se utilizzata, deve essere ininterrotta		
Pressione di funzionamento:			
• monostabile	vuoto ÷ 10 bar-pneumatiche - 2.5 ÷ 10 bar-elettropneumatiche		
• bistabile	vuoto ÷ 10 bar-pneumatiche - 1 ÷ 10 bar-elettropneumatiche		
• asservita	vuoto ÷ 10 bar		
Pressione minima asservimento o pilotaggio	2.5 bar		
Temperatura di funzionamento	-10° ÷ +60°C		
Diametro nominale	7.5 mm	12 mm	15 mm
Conduttanza C	250 NI/min · bar	657.14 NI/min · bar	971.43 NI/min · bar
Rapporto critico b	0.36 bar/bar	0.25 bar/bar	0.43 bar/bar
Portata a 6 bar ΔP 0.5 bar	700 NI/min	1800 NI/min	3200 NI/min
Portata a 6 bar ΔP 1 bar	1100 NI/min	2700 NI/min	4600 NI/min
Installazione	In qualsiasi posizione (Per le bistabili, se soggette a vibrazioni, è sconsigliato il montaggio verticale)		
Montaggio	Su basi singole e manifold a norme ISO 5599/1		
Lubrificante consigliato	ISO e UNI FD 22		
Elettropilota:	norme CNOMO / in linea / M12		norme CNOMO
Manuale:	Bistabile sull'elettropilota Monostabile sul corpo valvola		
Coppia max ghiera bobina	1 Nm		
Compatibilità con olii	vedere catalogo generale pag. 6.1/08 o collegarsi a www.metalwork.it/ita/materiali_compatibilita.html		

COMPONENTI

- ① CORPO VALVOLA: alluminio
- ② FONDELLO: HOSTAFORM®
- ③ SPOLA: Alluminio nichelato chimicamente
- ④ DISTANZIALI: Materiale plastico
- ⑤ GUARNIZIONI: Gomma nitrilica NBR
- ⑥ PISTONE: HOSTAFORM®
- ⑦ GUARNIZIONE PISTONE: Gomma nitrilica NBR
- ⑧ FILTRO: Bronzo sinterizzato
- ⑨ MOLLA: Acciaio speciale
- ⑩ OPERATORE: Tubo in ottone - Nucleo in inox

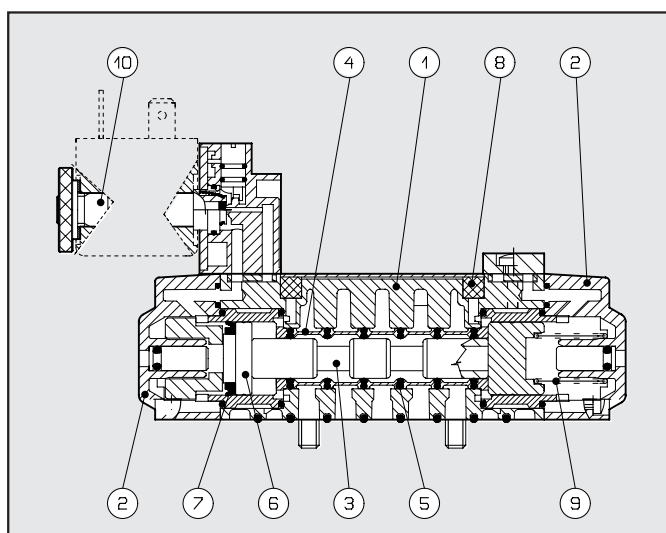





VALVOLE ISO 5599/1 PNEUMATICHE SERIE IPV

DATI TECNICI	ISO 1	ISO 2	ISO 3
Pressione di funzionamento	Vuoto ÷ 10 bar		
Pressione minima di azionamento:			
• monostabile	2.5 bar		
• bistabile	1 bar		
Temperatura di funzionamento	-10° ÷ +60°C		
Diametro nominale	7.5 mm	12 mm	15 mm
Conduttanza C	250 NI/min · bar	657.14 NI/min · bar	971.43 NI/min · bar
Rapporto critico b	0.36 bar/bar	0.25 bar/bar	0.43 bar/bar
Portata a 6 bar ΔP 0.5 bar	700 NI/min	1800 NI/min	3200 NI/min
Portata a 6 bar ΔP 1 bar	1100 NI/min	2700 NI/min	4600 NI/min
Tempi di risposta azionamento a 6 bar:			
• monostabile	12 ms	24 ms	35 ms
• bistabile	20 ms	30 ms	45 ms
Tempi di risposta riposizionamento a 6 bar:			
• monostabile	30 ms	43 ms	55 ms
• bistabile	20 ms	30 ms	45 ms
Manuale	Monostabile sul corpo valvola		

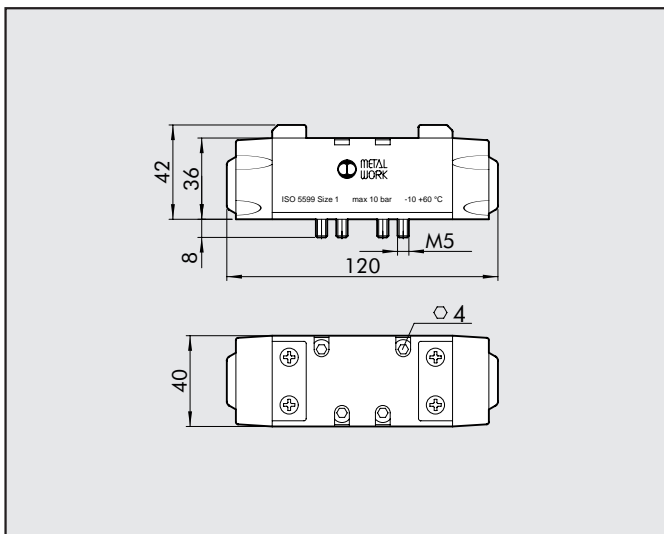



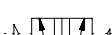
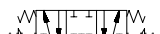



AZIONAMENTO PNEUMATICO ISO 1

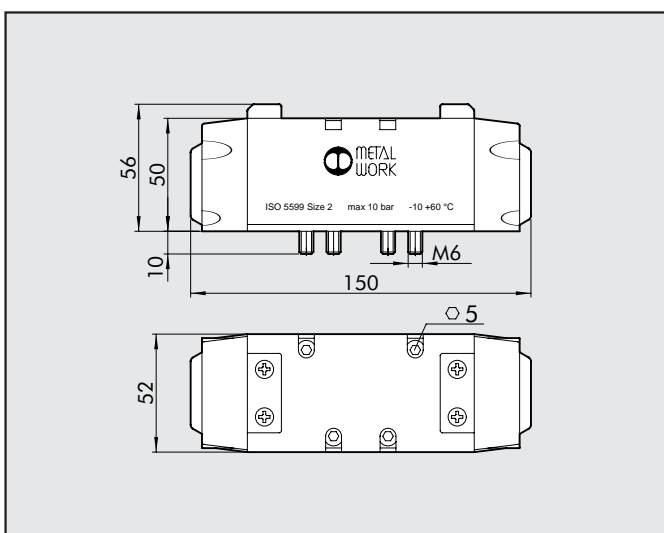

Simbolo	Sigla	Codice	Peso [g]
	IPV 55 PNS OO	7051011100	310
	IPV 55 PNB OO	7051012100	310
	IPV 55 PND OO	7051013100	310
	IPV 56 PNS CC	7051021100	310
	IPV 56 PNS OC	7051022100	310
	IPV 56 PNS PC	7051023100	310

AZIONAMENTO PNEUMATICO ISO 2

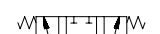
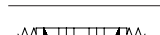

Simbolo	Sigla	Codice	Peso [g]
	IPV 65 PNS OO	7052011100	705
	IPV 65 PNB OO	7052012100	705
	IPV 65 PND OO	7052013100	705
	IPV 66 PNS CC	7052021100	705
	IPV 66 PNS OC	7052022100	705
	IPV 66 PNS PC	7052023100	705

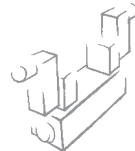

AZIONAMENTO PNEUMATICO ISO 3

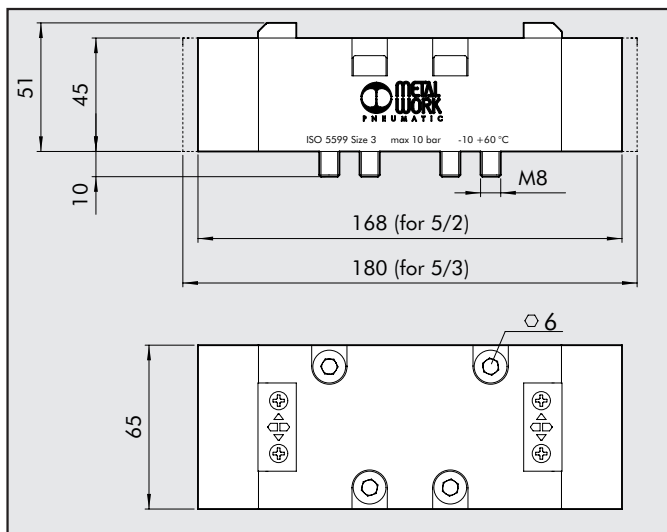







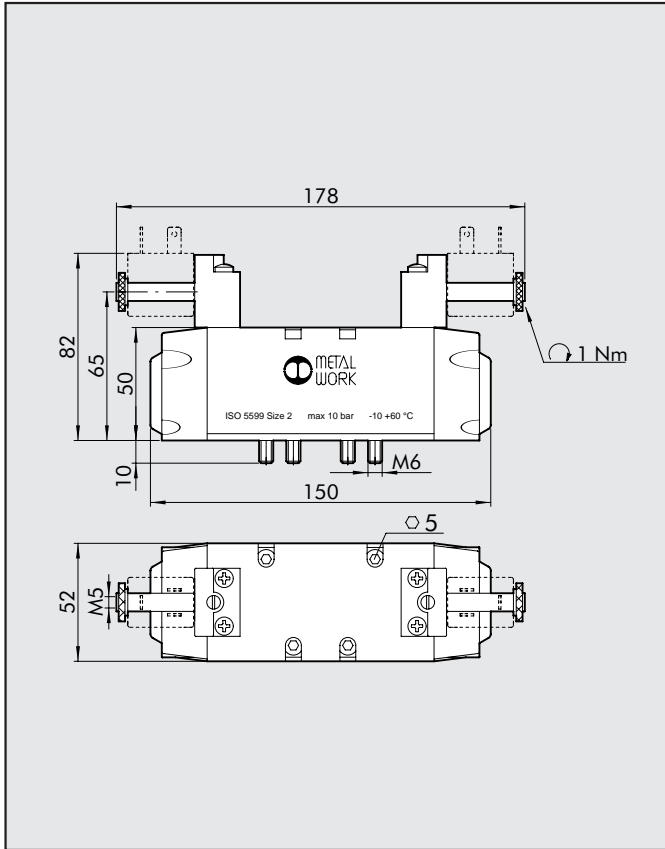

Simbolo	Sigla	Codice	Peso [g]
	IPV 75 PNS OO	7056011100	1175
	IPV 75 PNB OO	7056011200	1175
	IPV 75 PND OO	7056011300	1175
	IPV 76 PNS CC	7056012100	1290
	IPV 76 PNS OC	7056012200	1290
	IPV 76 PNS PC	7056012300	1290

NOTE

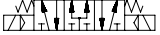

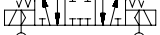

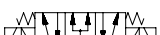

BISTABILE 5/2 ISO 2
MONOSTABILE 5/3 ISO 2

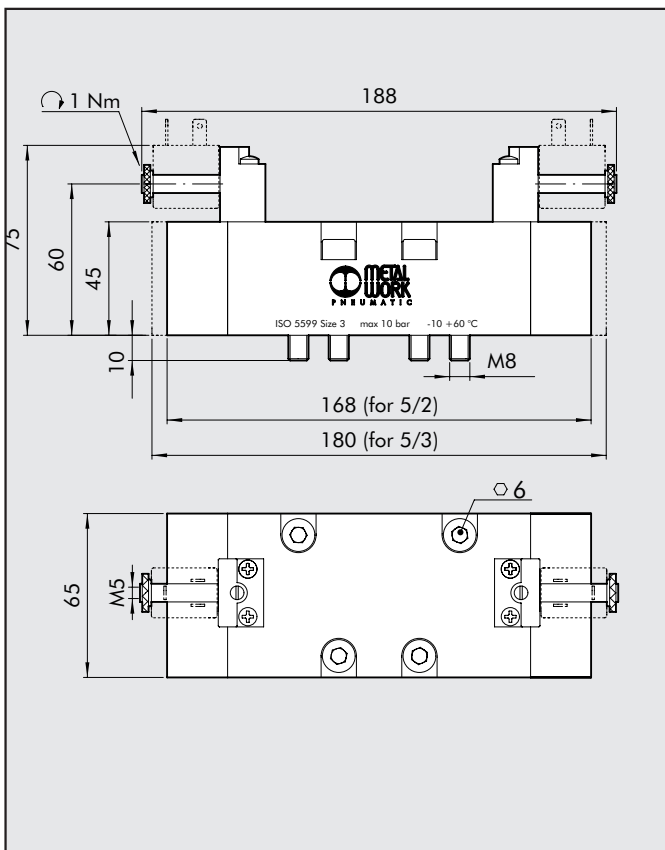

Simbolo	Sigla	Codice	Peso [g]
	ISV 65 SOB OO	7052021200	740
	ISV 65 SOD OO	7052021300	710
	ISV 66 SOS CC	7052022100	720
	ISV 66 SOS OC	7052022200	720
	ISV 66 SOS PC	7052022300	720
	ISV 65 SEB OO	7052021500	740
	ISV 65 SED OO	7052021600	710
	ISV 66 SES CC	7052022400	720
	ISV 66 SES OC	7052022500	720
	ISV 66 SES PC	7052022600	720

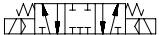
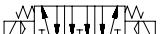
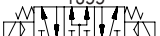
BISTABILE 5/2 ISO 3
MONOSTABILE 5/3 ISO 3

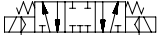

Simbolo	Sigla	Codice	Peso [g]
	ISV 75 SOB OO	7056021200	1230
	ISV 75 SOD OO	7056021300	1230
	ISV 76 SOS CC	7056022100	1355
	ISV 76 SOS OC	7056022200	1355
	ISV 76 SOS PC	7056022300	1355
	ISV 75 SEB OO	7056021500	1230
	ISV 75 SED OO	7056021600	1230
	ISV 76 SES CC	7056022400	1355
	ISV 76 SES OC	7056022500	1355
	ISV 76 SES PC	7056022600	1355

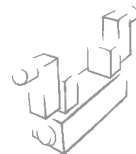

BOBINE E CONNETTORI PER ELETTROVALVOLE ISO 5599/1 SERIE ISV

BOBINE LATO 22 mm ELETTROVALVOLE ISO 5599/1

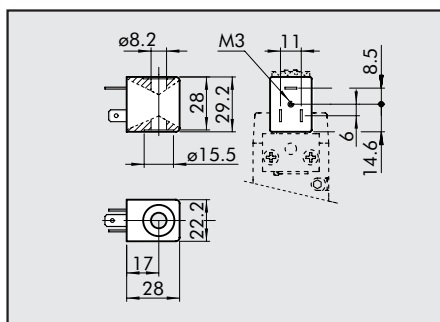

- Tolleranze di tensione: -10%+15%
- Classe di isolamento: F155
- Grado di protezione: IP65 EN60529 con connettore
- Non esporre continuamente agli agenti atmosferici
- Temp. max bobina a ED 100%: 70°C a 20° ambiente
- A normativa Atex 94/9 CE, gruppo II, categoria 3 GD

Tensione nominale	Assorbimento		Sigla	Codice
	Spunto	Regime		
12Vcc	2W	2W	Bobina 22 Ø8 BA 2W-12VDC	W0215000151
24Vcc	2W	2W	Bobina 22 Ø8 BA 2W-24VDC	W0215000101
24V 50/60Hz	5.3VA	3.5VA	Bobina 22 Ø8 BA 3.5VA-24VAC	W0215000111
110V 50/60Hz	5.3VA	3.5VA	Bobina 22 Ø8 BA 3.5VA-110VAC	W0215000121
220V 50/60Hz	5.3VA	3.5VA	Bobina 22 Ø8 BA 3.5VA-220VAC	W0215000131

BOBINE LATO 30 mm ELETTROVALVOLE ISO 5599/1 SERIE ISV

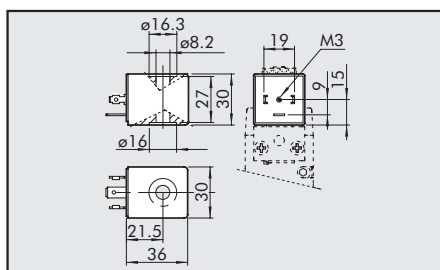

- Contatto elettrico DIN43650 Forma A-ISO 4400
- Tolleranze di tensione: -10%÷ -10%
- Classe di isolamento: F155
- Grado di protezione: IP65 EN60529 con connettore
- Non esporre continuamente agli agenti atmosferici
- A normativa Atex 94/9 CE, gruppo II, categoria 3 GD

Tensione nominale	Assorbimento		Sigla	Codice
	Spunto	Regime		
24Vcc	5W	4W	Bobina 30 Ø8 4W-24VDC	W0210010100
24V 50/60Hz	10VA	4VA	Bobina 30 Ø8 4VA-24VAC	W0210011100
110V 50/60Hz	10VA	4VA	Bobina 30 Ø8 4VA-110VAC	W0210012100
220V 50/60Hz	10VA	4VA	Bobina 30 Ø8 4VA-220VAC	W0210013100

CONNETTORE ELETTRICO PER BOBINE LATO 22 mm

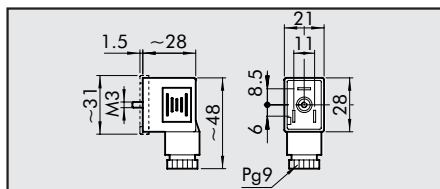

Colore	Ø Cavo	Tipo	Codice
Nero	PG9	Standard	W0970510011
Trasp.	PG9	LED 24V	W0970510012
Trasp.	PG9	LED 110V	W0970510013
Trasp.	PG9	LED 220V	W0970510014
Trasp.	PG9	LED + VDR 24V	W0970510015
Trasp.	PG9	LED + VDR 110V	W0970510016
Trasp.	PG9	LED + VDR 220V	W0970510017

CONNETTORE ELETTRICO PER BOBINE LATO 30 mm

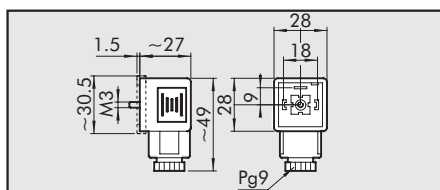

Colore	Ø Cavo	Tipo	Codice
Nero	PG9	Standard	W0970520033
Trasp.	PG9	LED 24V	W0970520034
Trasp.	PG9	LED 110V	W0970520035
Trasp.	PG9	LED 220V	W0970520036
Trasp.	PG9	LED + VDR 24V	W0970520037
Trasp.	PG9	LED + VDR 110V	W0970520038
Trasp.	PG9	LED + VDR 220V	W0970520039

KIT BOBINE EEXM

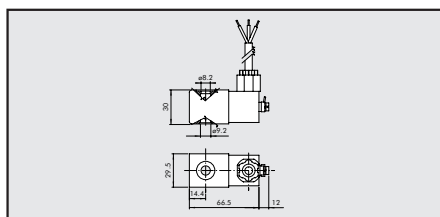

Codice	Descrizione
0227606913	KIT BOBINA 30 24 VDC EEXMT5 CABLE 3M
0227606915	KIT BOBINA 30 24 VDC EEXMT5 CABLE 5M
0227608013	KIT BOBINA 30 24 VAC EEXMT5 CABLE 3M
0227608015	KIT BOBINA 30 24 VAC EEXMT5 CABLE 5M
0227608023	KIT BOBINA 30 110 VAC EEXMT5 CABLE 3M
0227608025	KIT BOBINA 30 110 VAC EEXMT5 CABLE 5M
0227608033	KIT BOBINA 30 230 VAC EEXMT5 CABLE 3M
0227608035	KIT BOBINA 30 230 VAC EEXMT5 CABLE 5M

Bobine a normativa Atex 94/9 CE, gruppo II, categoria 2 GD

KIT PER BOBINE LATO 22 IP65



Codice	Descrizione
0222100100	KIT PER BOBINE 22 - IP65

Migliora la tenuta IP65, anche in caso di esposizione prolungata ad agenti atmosferici.
È applicabile a valvole con comando in tecnopolimero