

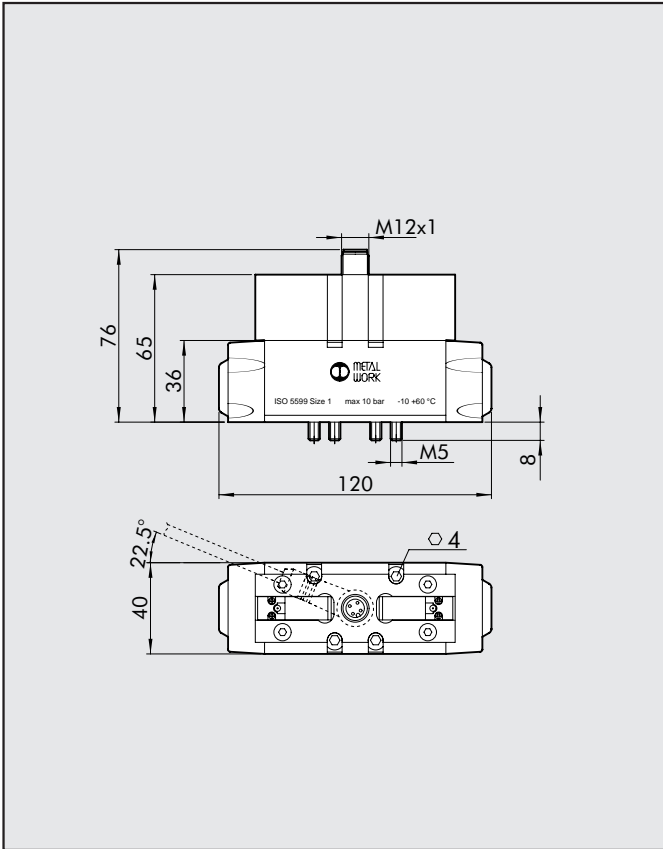









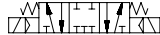

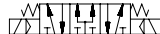

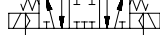

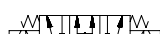
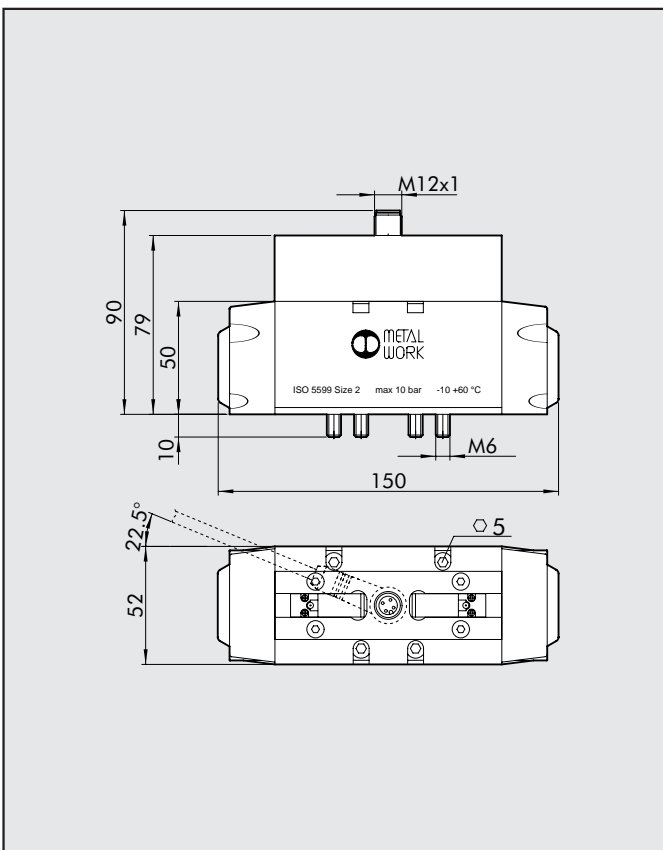

**BISTABLE 5/2 ISO 1
MONOSTABLE 5/3 ISO 1**

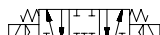

Symbol	Abbrev.	Code	Weight [g]
	ISV 55 COB OO	7054021200	512
	ISV 55 COD OO	7054021300	490
	ISV 56 COS CC	7054022100	496
	ISV 56 COS OC	7054022200	496
	ISV 56 COS PC	7054022300	496
	ISV 55 CEB OO	7054021500	512
	ISV 55 CED OO	7054021600	490
	ISV 56 CES CC	7054022400	496
	ISV 56 CES OC	7054022500	496
	ISV 56 CES PC	7054022600	496

**BISTABLE 5/2 ISO 2
MONOSTABLE 5/3 ISO 2**



Symbol	Abbrev.	Code	Weight [g]
	ISV 65 COB OO	7055021200	860
	ISV 65 COD OO	7055021300	860
	ISV 66 COS CC	7055022100	868
	ISV 66 COS OC	7055022200	868
	ISV 66 COS PC	7055022300	868
	ISV 65 CEB OO	7055021500	860
	ISV 65 CED OO	7055021600	860
	ISV 66 CES CC	7055022400	868
	ISV 66 CES OC	7055022500	868
	ISV 66 CES PC	7055022600	868

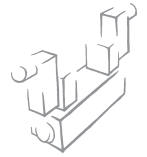

WIRING DIAGRAM

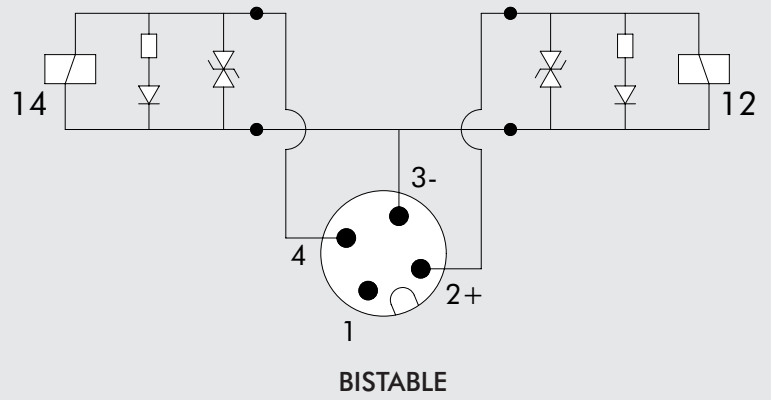
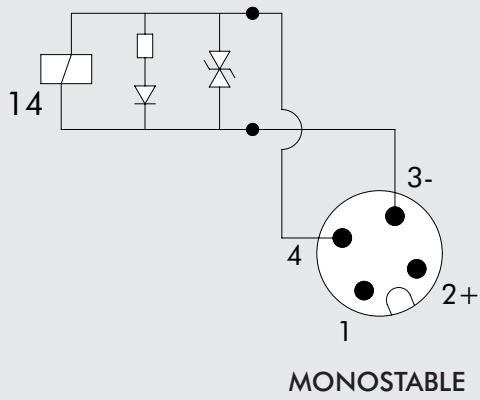

NOTES

Blank lined area for notes.