

# **REGTRONIC OPERATING INSTRUCTIONS**

---

## 1. FEATURES

- Electrical connection: M12 8-pin connector.
- Preset pressure range 0.05-10 bar with possible full scale and minimum pressure regulation.
- 10–100 mbar adjustable deadband.
- Supply pressure: FS+ at least 1 bar, max 11 bar.
- 24Vdc power supply.
- IP65 index of protection.
- LED indicating pressure achieved and digital output active.
- Graphical display and keypad to display the pressure, unit of measurement and parameter setting.
- 0-10 V analog output signal.

## 2. SETTING

**NB: parameter changes can also be effected through the software downloadable from the website [www.metalwork.eu](http://www.metalwork.eu)**

**To connect the PC to Regtronic you can use the cable code W0970513019.**

In the version with the display, Press OK and ESC together to access the setting menu.

Select the parameter using the arrow keys.

Press ESC to return to the previous page.



**During setting, pressure regulation is NOT active.**

### 2.1 DISPLAY

#### 2.1.1 LANGUAGE

Italiano  
English  
Deutsch  
Español  
Français

- Select **LANGUAGE** using the arrow keys, then press OK.
- Select the desired language using the arrow keys, then press OK.

#### 2.1.2 UNIT OF MEAS

bar  
psi  
MPa

- Select **UNIT OF MEAS.** using the arrow keys, then press OK.
- Select the desired unit of measurement using the arrow keys, then press OK.

#### 2.1.3 CONTRAST

- Manual display contrast adjustment
- Select **CONTRAST** using the arrow keys, then press OK.
- Select the value using the arrow keys, then press OK.
- Compensation as a function of temperature is automatic.

### 2.2 SET UP

#### 2.2.1 INPUT

0 / 10 V  
0 / 5 V  
4 / 20 mA  
RS232  
Keypad

- Select **INPUT** using the arrow keys, then press OK.
- Select the type of input using the arrow keys and then press OK.
- For the type of analog input (0/10V-0/5V-4/20mA), use an appropriate analog signal.
- For the type of RS232 input, use the communication protocol described in chapter 12.
- For the type of keypad input, set the pressure value using the arrow keys. When you press the display buttons, the set pressure appears; when you release them, the preset pressure is displayed.

### 2.2.2 DEADBAND

This indicates the pressure range in proximity to the set pressure, within which regulation is active. The deadband is + and - the set value. It is advisable to enter low values, 10 or 15 mbar, only if high regulation accuracy is required. High accuracy involves more work for the solenoid valves.

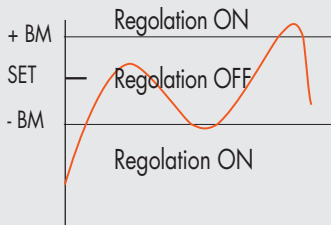

- Select **DEADB** using the arrow keys, then press OK.
- Enter the value using the arrow keys, then press OK.

### 2.2.3 FULL SCALE

This indicates the maximum preset pressure. The analog command is divided over the Full Scale. The analog output signal indicates that the preset pressure is 0-10V for 0-10 bar.

Examples with maximum preset pressure 3, 5 and 10 bar

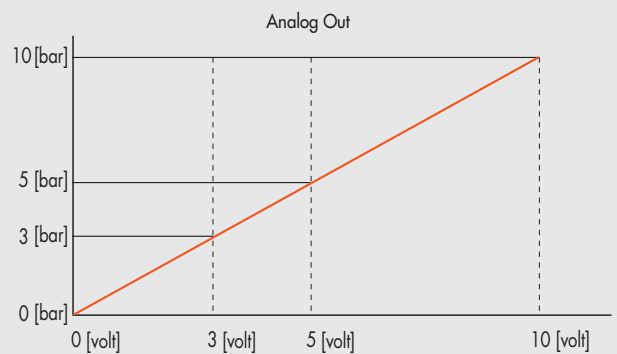
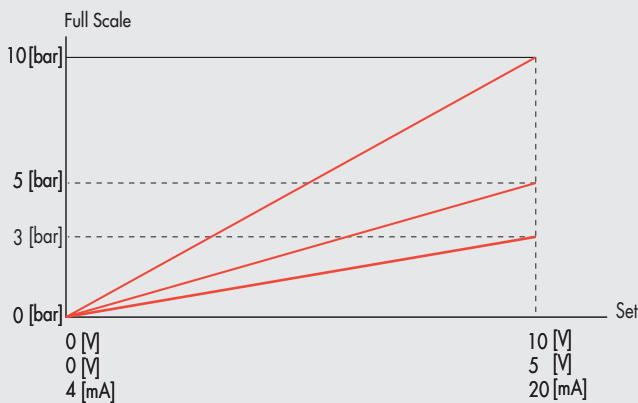

**For optimal regulation, the feed pressure must be FS + 1 bar.**

### 2.2.4 MINIMUM PRESSURE

Indicates the minimum regulated pressure with set 0V (4 mA). The value can be set between 0 and 50% of the Full Scale set. The reference set is divided between the Minimum Pressure value and the Full Scale value.

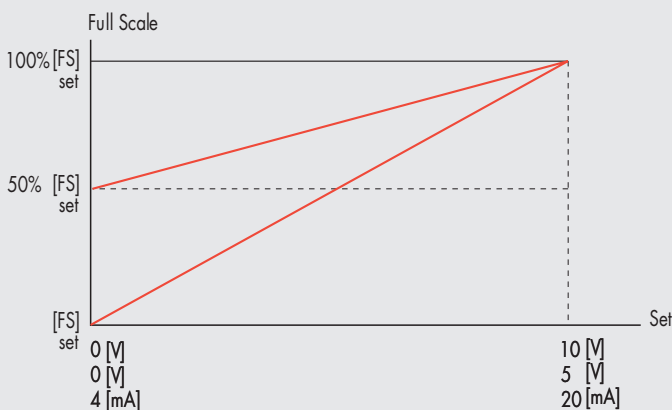

**The minimum value which can be set with Keyboard Set is the Minimum Pressure value.**  
**If the "Minimum pressure" function is used, the "Analogue input filter" function must be set to 0.**

### 2.2.5 RS232

Enables serial transmission, irrespective of the type of input.

### 2.2.6 REGULATION SPEED

It allows to modify the response speed of the regulator

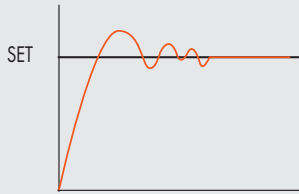

V=5 fast regulation

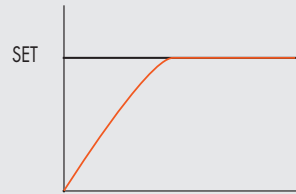

V=1 slow regulation

### 2.2.7 ANALOGUE INPUT FILTER

The analogue input filter can be used to set an offset value on the analogue signal. The pressure is kept to 0 until the offset value is reached, and the LED PRESSURE flashes. In this way, it is possible to filter any unwanted noise or small signals from analogue boards, which would cause undesired small and continuous pressure regulations. The setting ranges from 0 to 30 and corresponds to an offset of 0-110 bar, 0-110 mV and 4-4.25 mA. The default value is 2, which corresponds to 25 mbar.

## 2.3 DIGITAL OUTPUT

Two digital outputs are available, one PNP and one NPN. They can be configured independently as normally open or normally closed. The P ON (P+) and P OFF (P-) activation/deactivation thresholds are unique.

### 2.3.1 PRESSURE SWITCH CONFIGURATION (P)

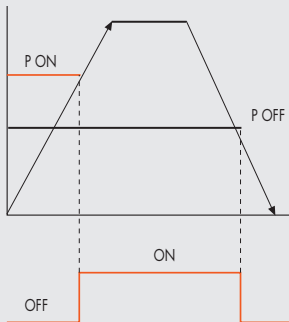

- Select **OUTPUT** using the arrow keys, then press OK.
- Select **CONFIGUR.** to select the operating mode, then press OK.
- Select **PRESSURE SWITCH**, then press OK. **PRESSURE SWITCH** mode, shown with **CONFIGUR. P.** has been selected.
- Use the arrow keys to select **PRESSURE SWITCH** and press OK.
- Select **P ON** and press OK. Enter the desired activation pressure and press OK.
- Select **P OFF** and press OK. Enter the desired deactivation pressure and press OK.
- Press ESC to exit the menu.

### 2.3.2 SET (S) REFERENCE

This function can be used to make a "variable" setting for the pressure switch.

Out is activated when the preset pressure is reached, with a tolerance defined by P+ and P-.

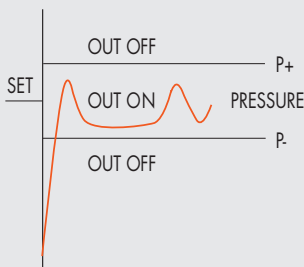

- Select **OUTPUT** using the arrow keys, then press OK.
- Select **CONFIGUR.** to select the operating mode, then press OK.
- Select **SET. REF** and press OK. SET REFERENCE mode, shown with **CONFIGUR. S.** has been selected.
- Use the arrow keys to select **PRESSURE SWITCH** and press OK.
- Select **SET.REF** and press OK.
- Select **P+** and press OK.
- Enter the upper tolerance pressure and press OK.
- Select **P-** and press OK. Enter the lower tolerance pressure and press OK.
- Press ESC to exit the menu.

### 2.3.3 TYPE OF CONTACT

This function is used to identify whether the digital output is normally open or normally closed.

- Select **TYPE OF CONTACT** and click OK.
- Select **TYPE PNP** or **TYPE NPN**, click OK and enter the type of contact.
- Click ESC to exit.

## 2.4 DATABASE

Serial number

Software version

Hour counter: indicates the operating time in hours.

## 2.5 DEBUG

Utility used for checking correct operation of the two solenoid valves.

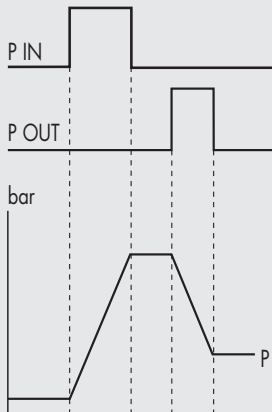

- Select **DEBUG** and press OK.
- Select **PIN** and press OK. The in solenoid valve activates and the pressure increases.
- Press OK. The in solenoid valve deactivates and pressure stabilizes.
- Select **POUT** and press OK. The out solenoid valve activates and pressure decreases.
- Press OK, the out solenoid valve deactivates and pressure stabilizes.

## 2.6 PASSWORD

This is a three-digit code used to protect the set configuration.

- Select **SET PASSWORD** with the arrow keys and click OK. On the setting page, use the arrow keys to enter the desired value and click OK to confirm. The system then displays the confirmation message "**PASSWORD SAVED**".
- Select **PASSWORD** and click OK to enable/disable the function. If the password set to **ON**, it prevents access to the configuration menu. When you press OK+ESC together to access the configuration menu, you are prompted to enter the password. Enter the saved password. You can use the arrow keys to change the value or click OK to change the field. If the password is set to **OFF**, it is not enabled.

If you forget the password, contact the manufacturer to obtain a password reset code.

## 3. ACCESS TO THE MENU

- Press OK to display the set parameters.
- Press OK and ESC together to access the parameter setting menu.
- Use the up and down arrows to scroll through the menu and modify the parameters.

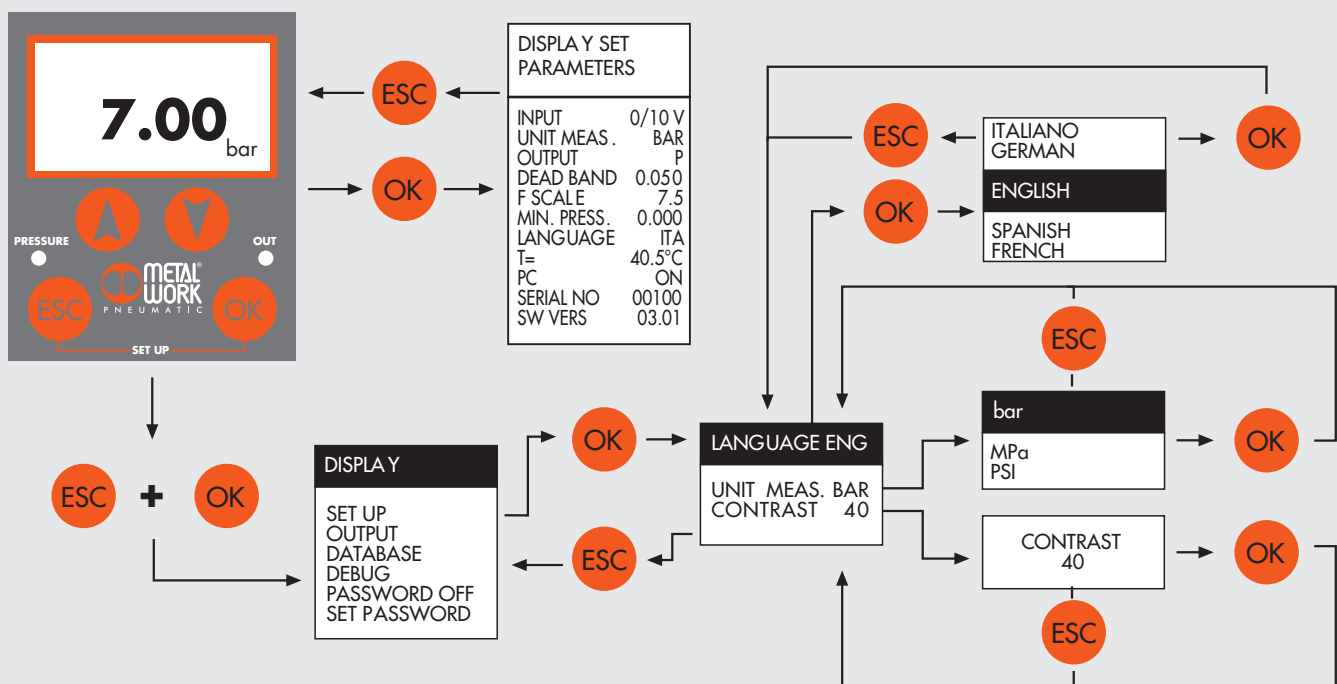

### 3. ACCESS TO THE MENU

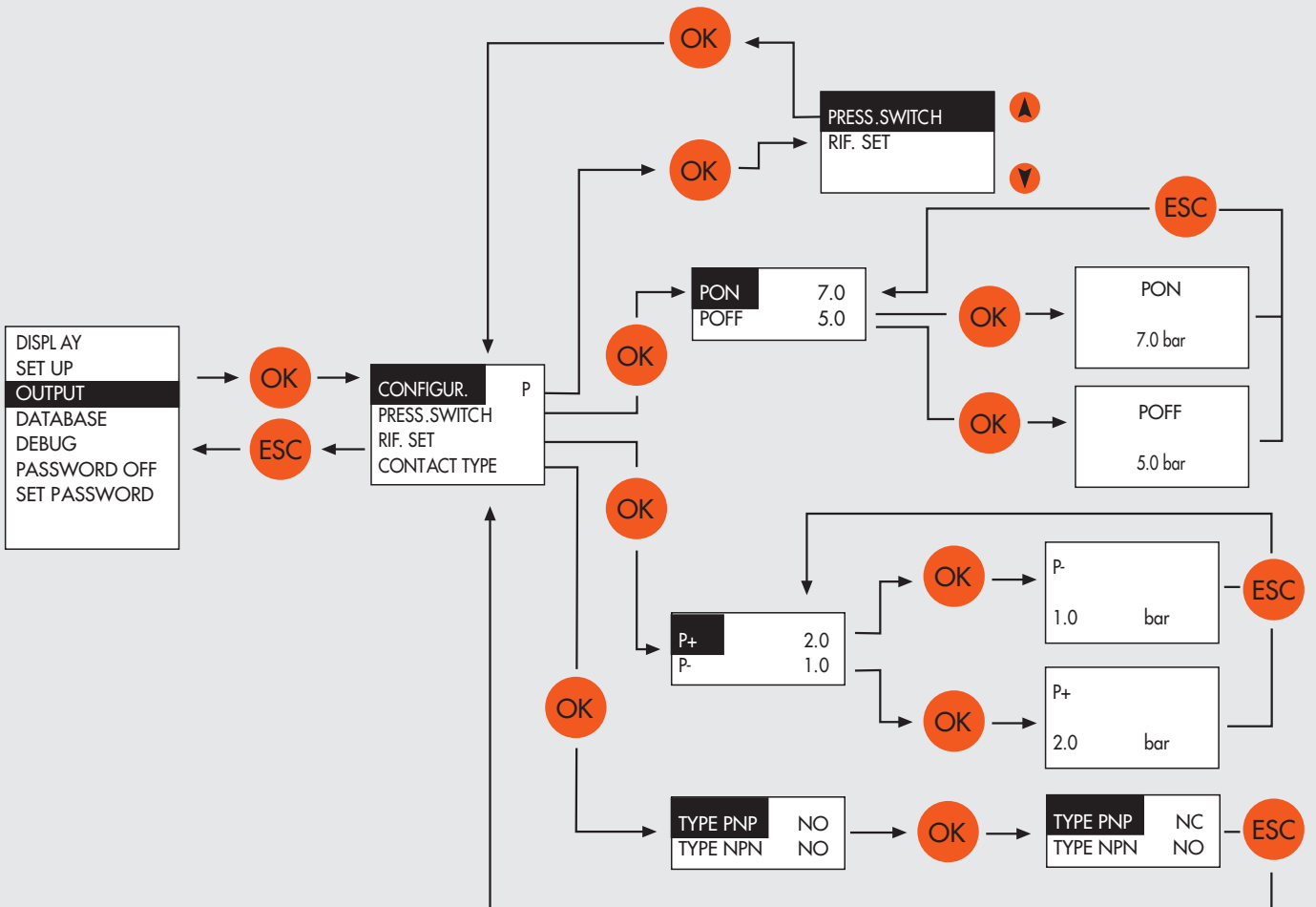
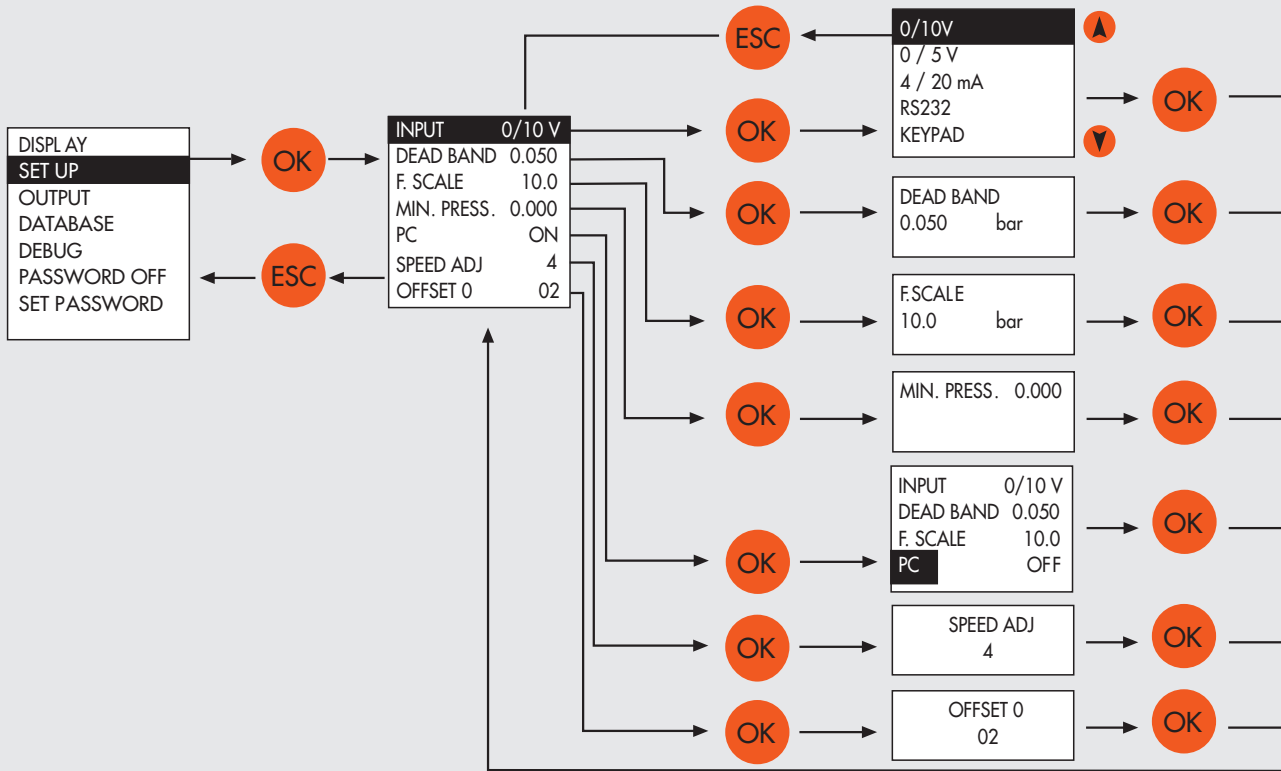

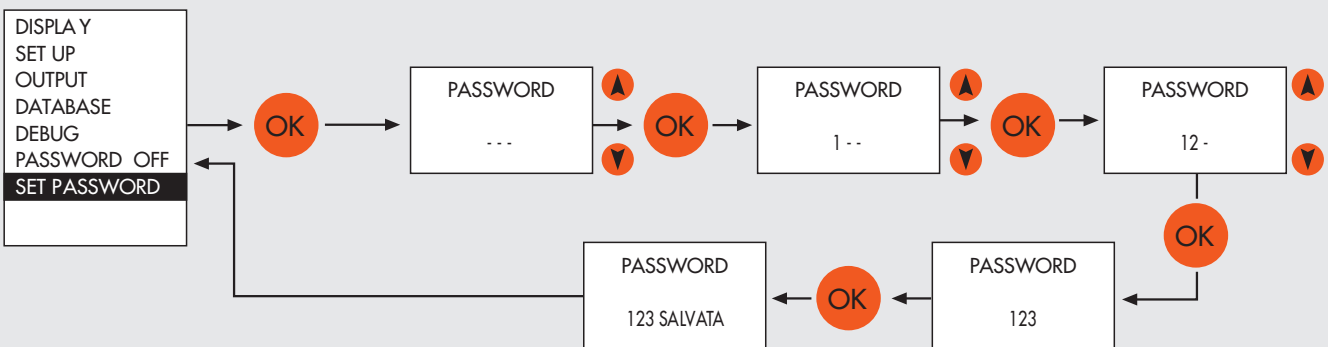
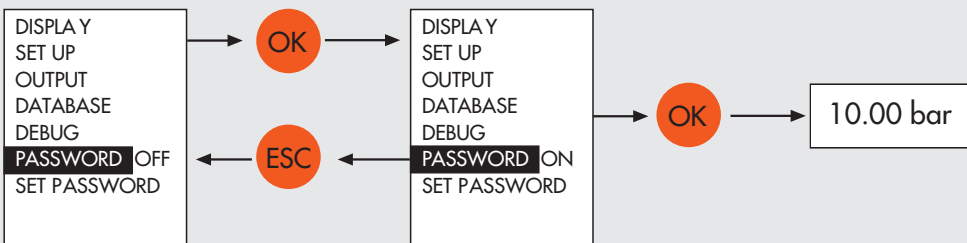
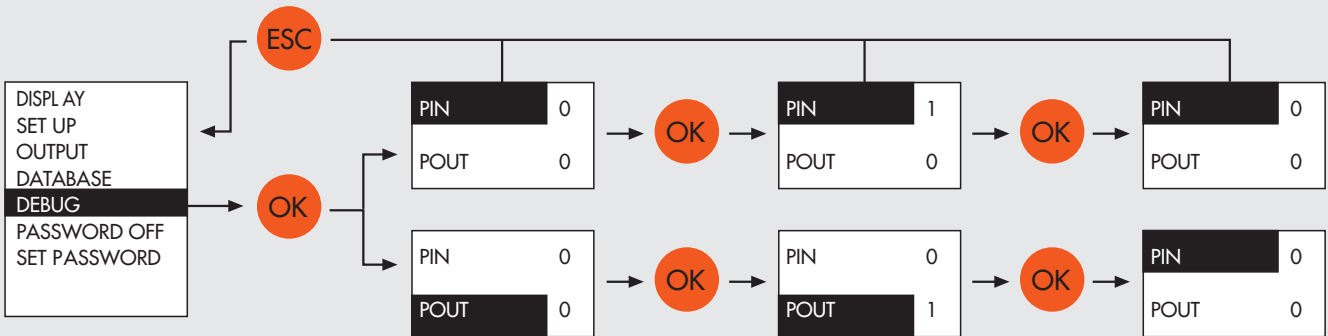
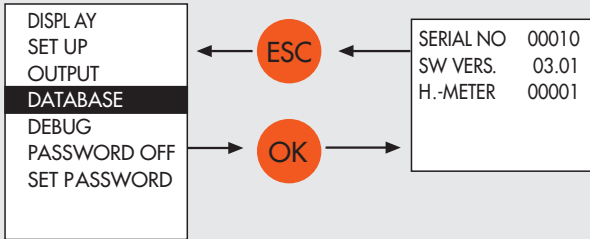

4. TECHNICAL DATA	REGTRONIC			REGTRONIC NEW DEAL		REGTRONIC 300		REGTRONIC 400					
	M5	1/8"	1/4"	3/4"	1"	1/2"	3/4"	1"	1"	1 1/4"	1 1/2"	2"	
Threaded part	M5   1/8"   1/4"   3/4"   1"   1/2"   3/4"   1"   1"   1 1/4"   1 1/2"   2"												
Fluid	Filtered, unlubricated air. The air must be filtered at least 10 µm												
MIN inlet pressure	bar			Regulation pressure +1 bar									
MAX inlet pressure	bar			11									
Temperature range	°C			0 ÷ 50									
Pressure regulation range	bar			0.05 ÷ 10 (settable full scale and minimum pressure)									
Flow rate at 6.3 bar ΔP 0.5	Nl/min	10	770	1490	10000	4500	18000	20000					
Flow rate at 6.3 bar ΔP 0.1	Nl/min	10	1050	1700	13000	7000	-	-					
Exhaust flow rate at 6.3 bar with 0.1 bar overpressure	Nl/min	2	320	500	1800	250	400	400					
Exhaust flow rate at 6.3 bar with 0.5 bar overpressure	Nl/min	9	650	1200	2000	500	850	850					
Weight	kg	0.2	0.38	0.38	1.3	1.5	5	5.8					
Class of protection	65												
Power supply	24 Vcc +10% -5% I max 110 mA												
Input signal (input impedance)	Voltage	0 ÷ 5 Vcc, 0 ÷ 10 Vcc (approx. 6.3 KΩ)											
	Current	4 ÷ 20 mA (approx. 100 Ω)											
	Serial ports	RS 232											
	Manual	Keypad											
Output signal	Analog	0 ÷ 10 Vcc (1 V=1bar) - 1 mA max											
	Digital	PNP open collector output: max 24V 60 mA NPN open collector output: max 24V 60 mA											
Linearity	≤ ± 0,5% (Full scale)												
Hysteresis	≤ ± 0,2% (Full scale)												
Repeatability	≤ ± 0,2% (Full scale)												
Sensitivity/Dead-band	setting range 10 ÷ 100 mbar												
Output pressure (display version)	Accuracy	≤ ± 0,3% (Full scale)											
	Unit of measurement	bar, MPa, psi											
	Minimum resolution	0.01 bar - 0.001 MPa - 0.01 psi											
Analog output accuracy	≤ ± 0,4% (Full scale)												
Temperature characteristics	max 2 mbar / °C												
Response time with ΔP = 1 bar		volume 100 cc				volume 1000 cc							
from 6 to 7 bar	s	0.5	0.2		0.3	0.45		0.35					
from 7 to 6 bar	s	0.55	0.3		0.3	0.45		0.7					
Installation position	In any position												
Notes	The features shown refer to the static condition only. With air consumption on the output side, the pressure may vary												

## 5. INSTALLATION AND OPERATION

### 5.1 PNEUMATIC CONNECTION

Pneumatic connection is via the threaded holes in the body.

It is important for the regulator pressure not to exceed 11 bar and the compressed air to be filtered at 10 µm and dried, to prevent impurities or excessive condensate from causing a malfunction.

The supply pressure must always be higher than the preset pressure.

The regulator pressure must be at least 1 bar higher than the full scale value.

If a silencer is mounted on the outlet, the flow rates and response times may vary. Check the silencer periodically for clogging and replace if necessary.

### 5.2 ELECTRICAL CONNECTION

This is by means of M12 female circular 8-pin connector (to be ordered separately).

Refer to the wiring diagram below.

**Wrong connections may permanently damage the regulator.**

#### 5.2.1 CONNECTOR PIN CONFIGURATION

1 = TX (RS232)	(WHITE)
2 = RX (RS232)	(BROWN)
3 = set 0-10 V / 0-5 V / 4-20 mA	(GREEN)
4 = digital out 0-24 V NPN	(YELLOW)
5 = analog out 0-10 V	(GREY)
6 = digital out 0-24 V PNP	(PINK)
7 = 0 V (GND)	(BLUE)
8 = power supply +24V	(RED)

colours' sequence in compliance with Metal Work prewired connectors.

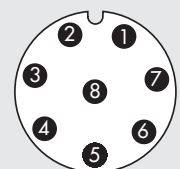

Regulator connector viewed from above



### 5.2.2 DIGITAL OUT CONNECTION

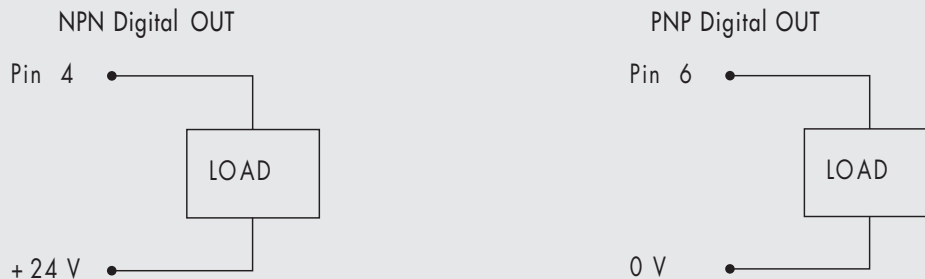

### 5.3 OPERATING PRINCIPLE

Using a software algorithm, the control circuit compares the input signal with the output pressure measured by the pressure sensor. When there is a change, it activates the inlet and outlet solenoid valves to re-establish an equilibrium. This gives an output pressure that is proportional to the input signal.

**N.B.:** removing the power supply, the outlet pressure doesn't get discharged

### 5.3.1 FUNCTION DIAGRAM

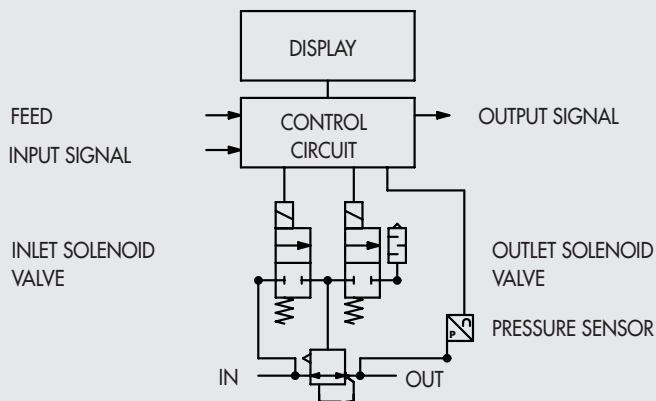

## 6. TROUBLESHOOTING

PROBLEM	POSSIBLE CAUSES	SOLUTION
The display does not come on	No 24V power supply	Check the power supply, make sure it is enough and check the wiring is in accordance with the wiring diagram
The unit does not respond or responds wrongly to the setpoint	Wrong input signal configuration	Configure the appropriate type of input from the menu  Check the signal wire is connected to the right pin
The unit does not reach the desired pressure	Setpoint too low  The full-scale setting is at a lower pressure than desired	Provide a suitable setpoint  Set the full scale correctly
The display shows an unreal value	The supply pressure is too low	Increase the supply pressure
The display is difficult to read	Wrong unit of measurement	Check the unit of measurement
The unit adjusts continually	Poor contrast	Adjust the contrast
	Air leak in the circuit after the unit	Eliminate the leak
	Continuous variation in volume	Normal behaviour; the unit has to keep adjusting the maintain the preset pressure
	Deadband too small	Increase the deadband
Other problems	Contact the manufacturer	

## 6.1 LIST OF ALLARMS

ALARM	POSSIBLE CAUSES	SOLUTION
+V NPN DOUT SHORT-CIRCUIT ALARM	NPN output to power supply unit has shortcircuited	Eliminate the cause of the shortcircuit. Switch the unit off and back on again to reset the alarm.
OV PNP DOUT SHORT-CIRCUIT ALARM	PNP output to earth has shortcircuited	Eliminate the cause of the shortcircuit. Switch the unit off and back on again to reset the alarm.
LOW YDC ALARM	Supply voltage below 21V	Increase to a sufficient voltage
OV P. INP SHORT-CIRCUIT ALARM	Supply solenoid valve has shortcircuited	Switch the unit off and back on again. If the alarm persists, contact the manufacturer.
OV P. OUT SHORT-CIRCUIT ALARM	Drain solenoid valve has shortcircuited	
P. INP DISCONNECTED ALARM	Fill solenoid valve disconnected	
P. OUT DISCONNECTED ALARM	Drain solenoid valve disconnected	
ANALOG SET ALARM	Occurs with 4/20 mA input when the current exceeds 23mA	Send the unit a correct input signal. Switch the unit off and back on again the reset the alarm.
PRESSURE OUT OF RANGE ALARM	Downstream pressure exceeds 10200 mbar	Check to see if the drain is blocked. The alarm resets automatically when the pressure drops below the threshold.

## 7. SERIAL COMMUNICATION PROTOCOL

Communication protocol can be used to configure and control the regulator via an PC serial port. To activate serial communication, set the RS232 to ON on the set-up page.

The communication protocol is 2400 8 N 1 (8 bits, no parity, 1 stop bit) and the commands are in ASCII format.

All commands are the following type:

**ESCnnnnn**

Where **ESC (Escape)** prepares the unit to receive commands, **c** is the command and **nnnnn** is the associated parameter, the length of which depends on the actual command.

For example, the control to regulate the pressure to 1 bar must be **ESCP01000**, which in ASCII-HEX becomes **1B503031303030**.

The available controls are shown herewith below.

- **Set Unit of measurement**

Sets the unit of measurement. The command is the following type:

**ESCcn**

Where **n** =

- 0 = pressure in bar
- 1 = pressure in MPA
- 2 = pressure in psi

If **n** is not one of these values, the unit does not change.

- **Set type of input**

Sets the type of control. The command is the following type:

**ESCdn**

Where **n** =

- 0 = 0-10V input
- 1 = 0-5V input
- 2 = 4-20mA input
- 3 = keypad input
- 4 = serial input

If **n** is not one of these values, the type of control does not change

- **Set Deadband**

Sets the deadband. The command is the following type:

**ESCbnnn**

Parameter **nnn** must always be 3 digits. The value must be expressed in mbar.

- **Set Full Scale**

Sets the full scale. The command is the following type:

**ESCEnnnnn**

Parameter **nnnnn** must always be 5 digits. The value must be expressed in mbar (e.g. ESCE7000, the set full scale is 7000 mbar)

- **Minimum pressure set**

Set the minimum regulated pressure with set 0.

The maximum value which can be set is the 50% of the FS. The control is type:

**ESCennnnn**

The parameter **nnnnn** must be always defined on 5 figures. The value must be expressed in mbar (For example, ESCe01000, the minimum pressure is set at 1000 mbar)

- **Digital output configuration**

Sets the type of digital output and the activation/deactivation values. The command is the following type:

**ESCO1sssssxxxxx**

Where:

1 = type of output (0 = pressure switch 1 = reference)

sssss = output activation threshold

xxxxx = output deactivation threshold

Parameters s and x must always be 5 digits. The value must be expressed in mbar.

- **Set Pressure**

Sets the pressure to reach. The command is the following type:

**ESCPnnnnn**

Parameter **nnnnn** must always be 5 digits. The value must be expressed in mbar (e.g. ESCP01001, the set pressure is 1001 mbar)

- **Read preset pressure**

Displays the preset pressure value. This command requires no parameters.

It is the following type:

**ESCp**

The response is:

**ESCpnnnnn**

Parameter **nnnnn** represents the pressure in mbar (e.g. ESCp05600, the preset pressure is 5.60 bar)

• **Read configuration**

Displays a string with complete module configuration. This command requires no parameters. It is the following type:

**ESCi**

The expected response is:

**ESCi05322b050c0d2E10000O10500002000e01000**

Where:

**05322** = the pressure reading

**050** = the deadband (b = the set deadband code)

**0** = the unit of measurement (c = the set unit of measurement code)

**2** = type of control (d = the set type of control code)

**10000** = the full scale (E = the code)

**1** = type of output (0 = pressure switch 1 = reference) (O = the code)

**05000** = output activation threshold

**02000** = output deactivation threshold

**01000** = minimum pressure

The type of parameter is indicated before the value, except for pressure.

**7.1 SERIAL CABLE CONNECTION DIAGRAM**

**M12 connector**

**9-pin D-Sub connector**

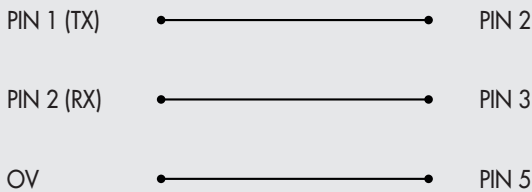

**8. LED INTERFACE**

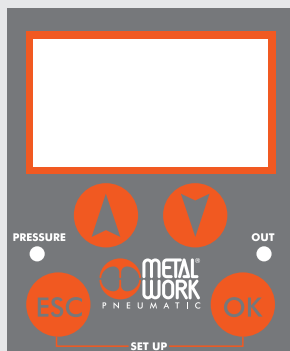
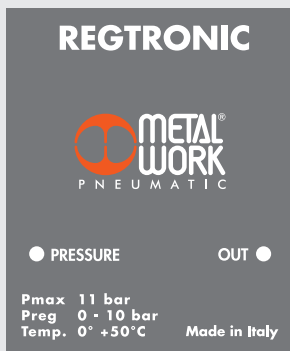

	LED PRESSURE	SOLUTION
	Flashing	In regulation
	ON	Regulation OFF
	OFF	No 24V power supply
	LED OUT	SOLUTION
	ON	Digital output active
	OFF	Digital output is not active